

Spare Parts

CORROSION ACTUATED PROBE LIFT

CXG030-00.4-

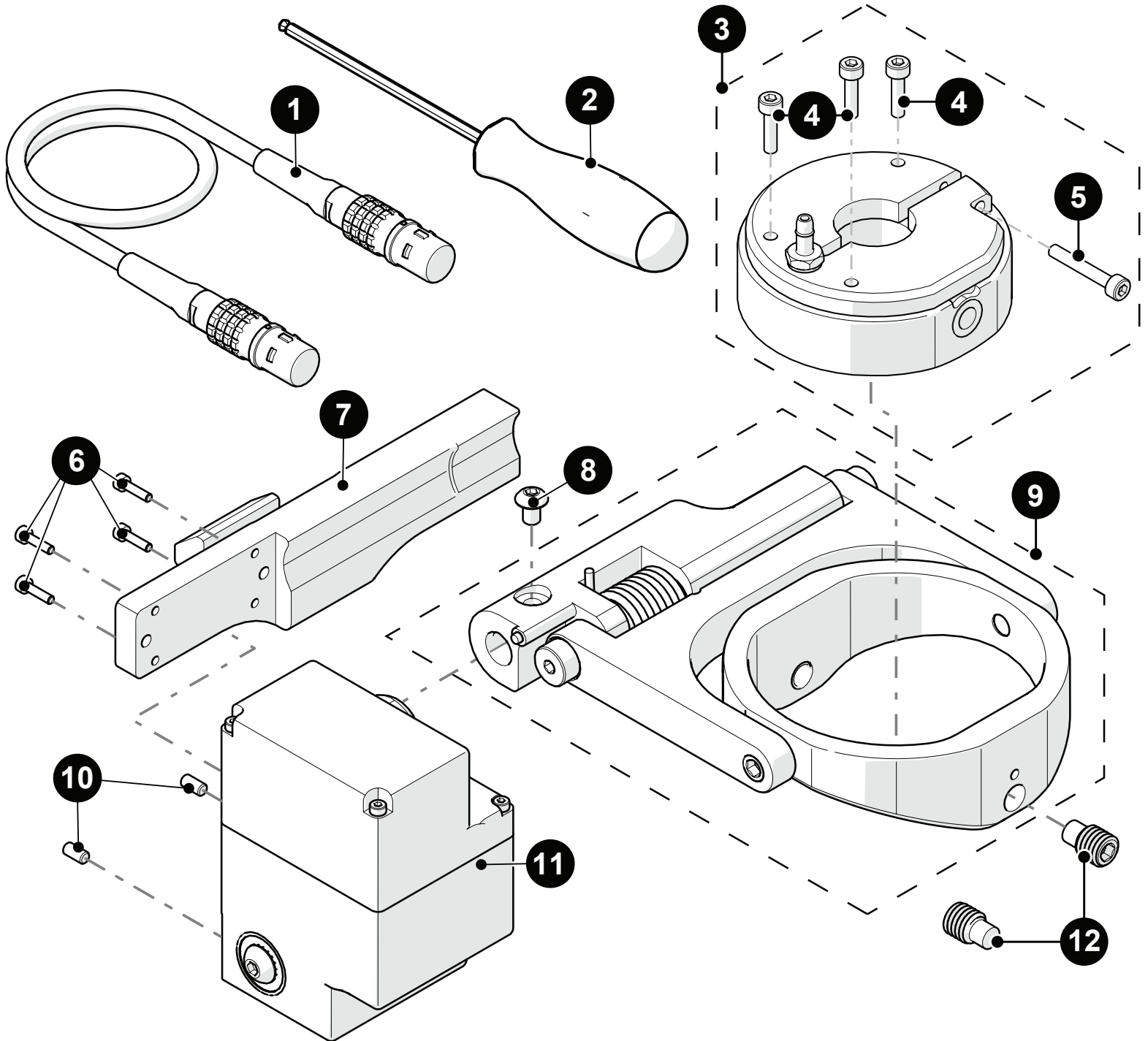

BOM ID	Part #	Description
1	UMA017-00.4	Auxiliary Cable 40 cm (1.3 ft)
2	EA599	2.5 mm (0.098 in) hex driver
3	<i>See Probe Holder Receptacle and Wear Plate</i>	
4	MD049-012	SHCS, M3x0.5 x 12 mm, SST
5	MD049-020	SHCS, M3x0.5 x 20 mm, SST
6	MD047-008	SHCS, M2x0.4 X 8 mm, SST
7	CX0414	Probe Lift Mounting Bracket
8	MD073-006	BHCS, M4x0.7 X 6 mm, SST
9	PHS073	Actuated Probe Lift Arm Assembly
10	MA240	PIN, Ø3 mm (h7) x 6 mm 440C Dowel
11	CXA026	Rotary Actuator Assembly
12	MA264	SHSS, M8 x 1.25 x 12 mm, dog point, SST

ACTUATED PROBE LIFTS

CXG037-

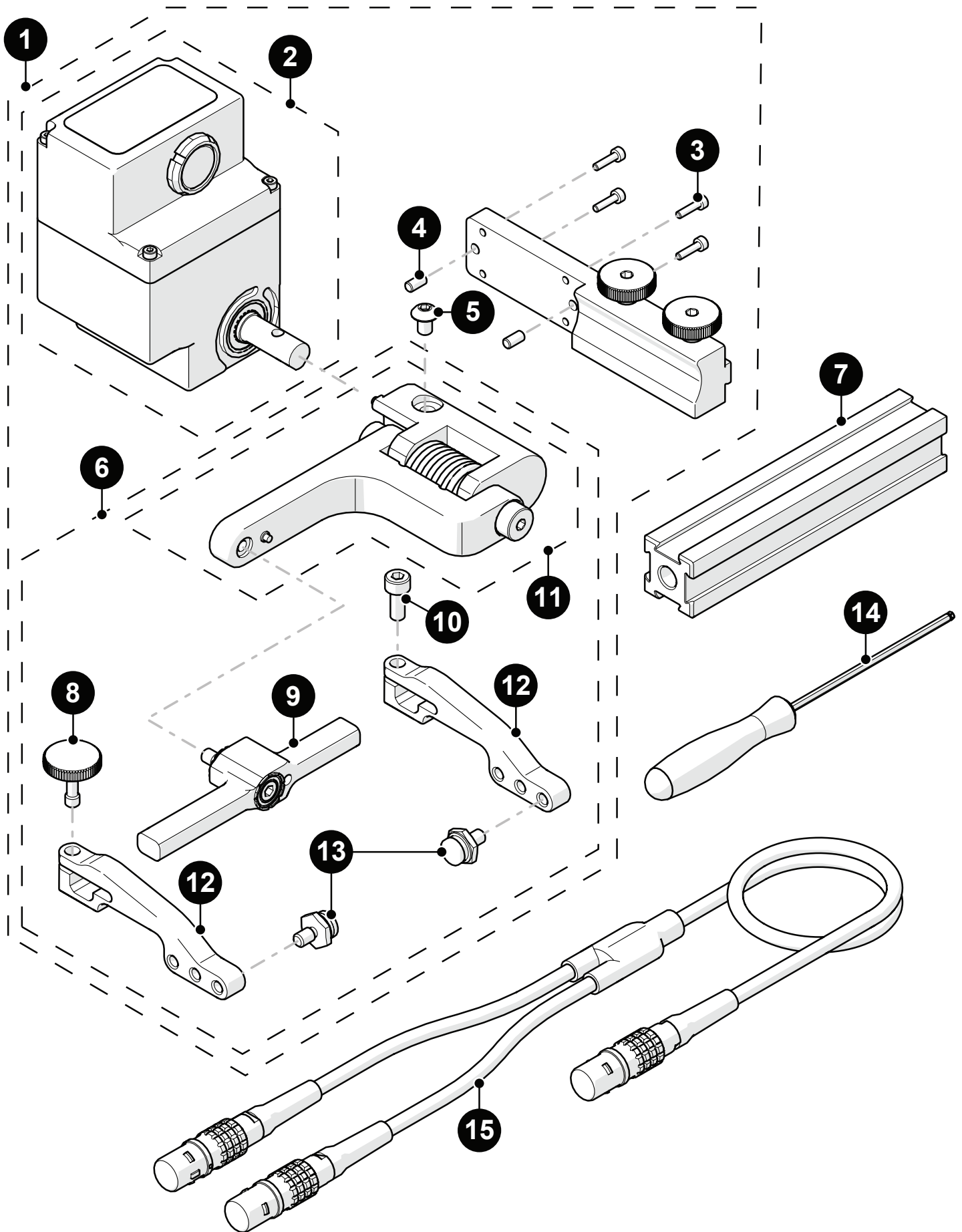









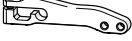

Spare Parts

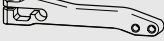
CXG037-











BOM ID	Part #	Description
1	CXA046-X-YY-R	Actuated Probe Lift (X - see arm style) (Y - see pivot button style) (R - Right side)
2	CXA026	Rotary Actuator Assembly - Right (CXA047 left is also available)
3	MD047-008	SHCS, M2x0.4 X 8 mm, SST
4	MA240	PIN, Ø3 mm (h7) x 6 mm 440C DOWEL
5	MD073-006	BHCS, M4x0.7 X 6 mm, SST
6	PHS087-X-YY-R	Actuated Probe Lift Arm Assembly (X - see arm style) (Y - see pivot button style) (R - Right side)
7	BG0038-10	Frame Bar: 10 cm (3.9 in) (see frame bars)
8	PH0082	Knurled knob, M4 x 0.7 x 10 mm, 3 mm stand off, SST
9	PHS063	Yoke Style: wide, 7.9 cm (3.06 in) (see yoke style)
10	MD050-010	SHCS, M4x0.7 X 10mm, SST
11	PHS091-R	Actuated Probe Lift Arm Sub-Assembly: Right
12	see Arm Style	
13	see Pivot Button Style	
14	EA476	2 mm (0.078 in) hex driver
15	UMA053-01	Split Auxiliary Cable: 1 m (3.3 ft)

NOTE: This list identifies parts available for the right side actuated probe lift. Similar parts for the left side are also available.

Arm Style

Arm Style	Part #	Image	Arm Style	Part #	Image
A Standard, Flat	PH0090		B Short, Flat	PH0089	
C Long, Flat	PH0099		D Standard, Drop	PH0093	
E Short, Drop	PH0092		F Long, Drop	PH0094	
G Standard, Extra-Drop	PH0096		H Short, Extra-Drop	PH0095	
I Extra-Short, Flat	PH0159		J Extra-Short, Drop	PH0161	

Pivot Button Style

Pivot Hole Size	Wedge Type	Image	Pivot Hole Size	Wedge Type	Image
01 8.0 mm (0.315 in)	Olympus PA		02 5.0 mm (0.197 in)	Olympus TOFD	
03 2.7 mm (0.106 in)	Sonatest DAAH PA		04 9.5 mm (0.375 in)	-	
06 3.0 mm (0.118 in)	-		07 2.3 mm (0.09 in)	-	
08 Conical Head	-		09 5 mm (0.197 in) Internal	Zetec PA/TOFD	
11 3 mm (0.118 in) Internal	-		14 4 mm (0.157 in)	-	

Spare Parts

Probe Holder Receptacle and Wear Plate

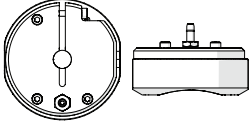
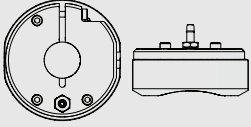
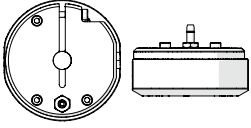
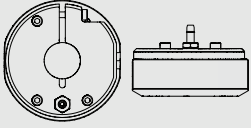
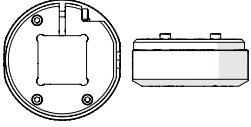
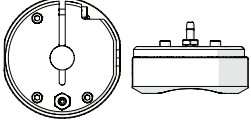
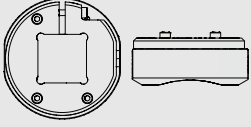
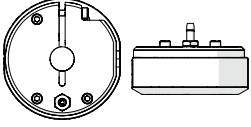
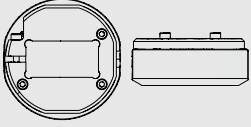
Part #	Wear Plate	Receptacle	
PHS066-A	Curved	9.53 mm (0.375 in) dia.	
PHS066-C	Curved	19 mm (0.75 in) dia.	
PHS067-A	Flat	9.53 mm (0.375 in) dia.	
PHS067-C	Flat	19 mm (0.75 in) dia.	
PHS067-E	Flat	25.4 mm (1 in)	
Part #	Wear Plate	Receptacle	
PHS066-B	Curved	12.7 mm (0.5 in) dia.	
PHS066-E	Curved	25.4 mm (1 in)	
PHS067-B	Flat	12.7 mm (0.5 in) dia.	
PHS067-D	Flat	Technisonic	

Yoke Style

Yoke Style	Part #	Length		Yoke Style	Part #	Length	
S Standard	PHS052	6.3 cm (2.47 in)		W Wide	PHS063	7.9 cm (3.06 in)	