

Spare Parts

■ STIX SCANNER

BGG001

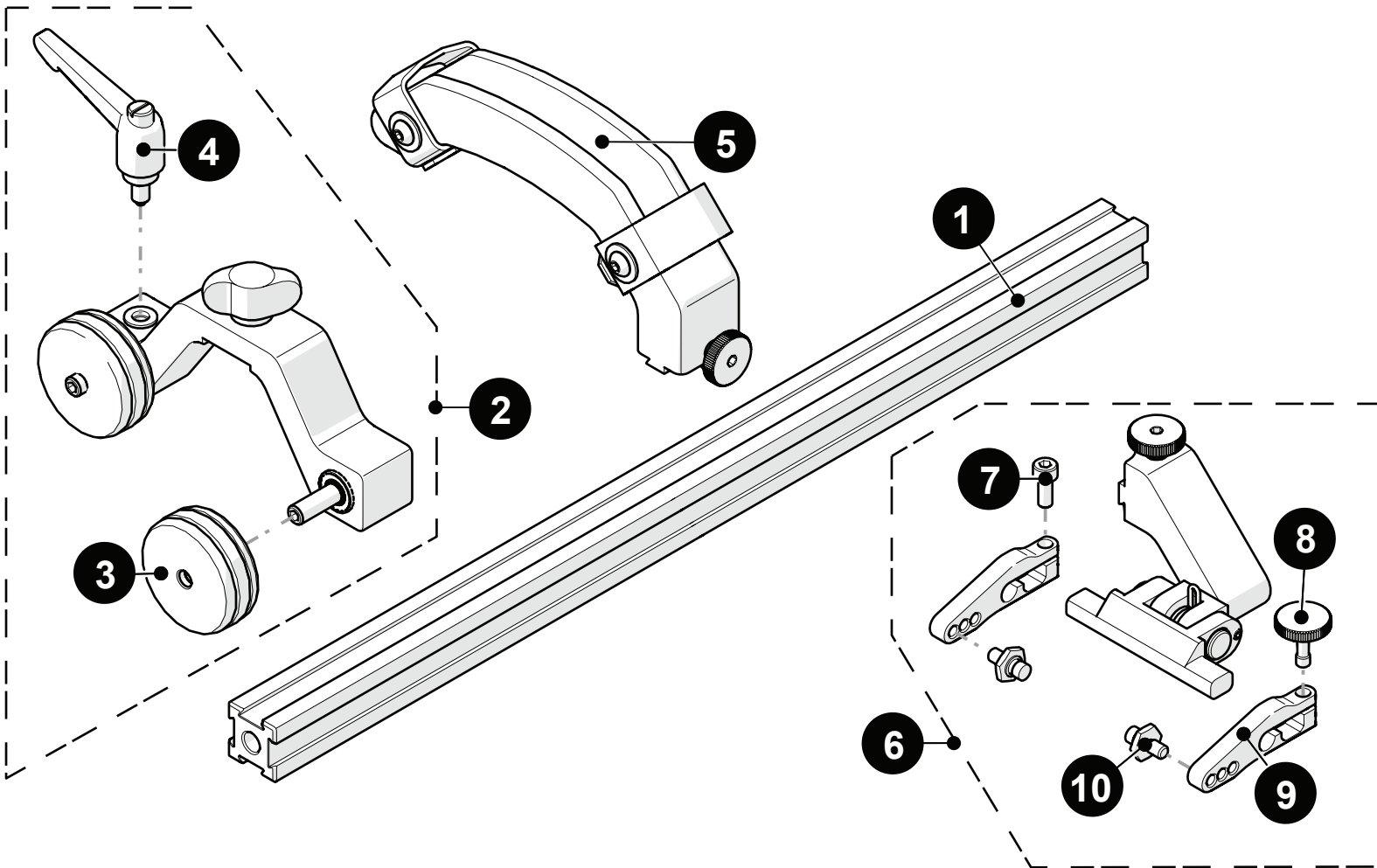









| BOM ID | Part # | Description |
|--------|------------|--|
| 1 | BG0038-35 | Frame Bar, 35 cm |
| 2 | BGS056 | Wheel Block |
| 3 | BTS031 | Magnetic Wheel |
| 4 | BTS018 | Brake Handle |
| 5 | BGS054 | Handle |
| 6 | PHS033-X-Y | Spring-Loaded Probe Holder (see <i>Pivot Button Style</i> , Y=L,R) |
| 7 | MD050-010 | SHCS, M4 x 0.7 x 10 mm, SST |
| 8 | PH0082 | Knurled Knob, M4 x 0.7 x 10 mm, 3 mm stand off, SST |
| 9 | | see <i>Spring-Loaded Arm Style</i> |
| 10 | PH0011-X | (see <i>Pivot Button Style</i>) |

Spare Parts

STIX SCANNER

Pivot Button Style

| | Pivot Hole Size | Wedge Type | |
|-----------|------------------|------------------|---|
| 01 | 8.0 mm (0.32 in) | Olympus PA |  |
| 03 | 2.7 mm (0.11 in) | Sonatest DAAH PA |  |
| 06 | 3.0 mm (0.12 in) | - |  |
| 08 | Conical Head | - |  |

| | Pivot Hole Size | Wedge Type | |
|-----------|-------------------------|---------------|---|
| 02 | 5.0 mm (0.20 in) | Olympus TOFD |  |
| 04 | 9.5 mm (0.38 in) | - |  |
| 07 | 2.3 mm (0.09 in) | - |  |
| 09 | 5 mm (0.20 in) Internal | Zetec PA/TOFD |  |

Spring-Loaded Arm Style

| | Arm Style | Part # | |
|----------|-----------|--------|--|
| A | Standard | PH0090 |  |

| | Arm Style | Part Number | |
|----------|-----------|-------------|--|
| B | Short | PH0089 |  |