

Spare Parts

MICROBE KIT

BTG005 | BTG006 | BTG007 | BTG013

JIREH.COM

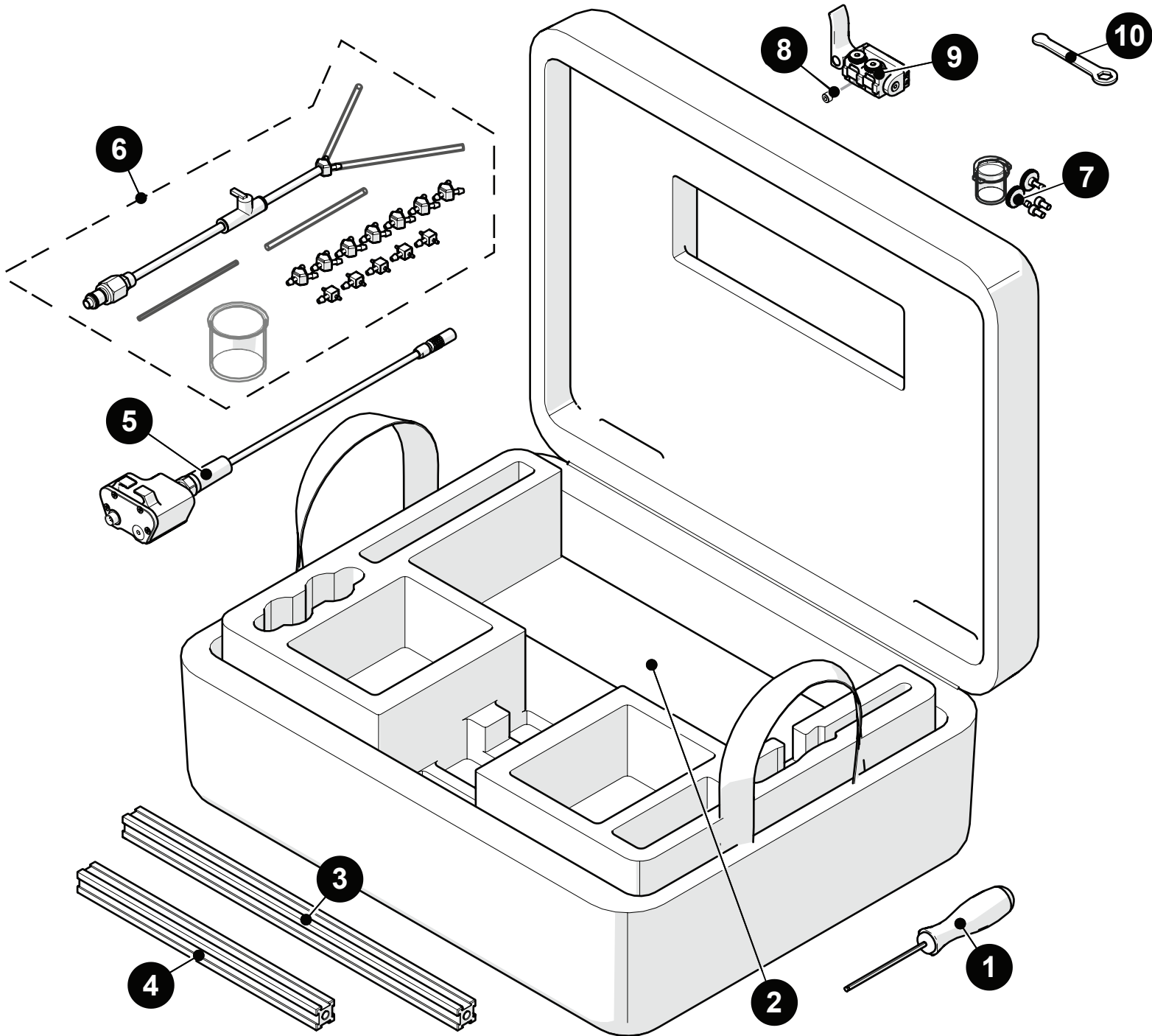

BOM ID	Part #	Description
1	EA414	3 mm Hex Driver
2	BTA002	MICROBE Case
3	BG0038-35	Frame Bar, 35 cm (see <i>Frame Bars</i>)
4	BG0038-25	Frame Bar, 25 cm (see <i>Frame Bars</i>)
5	UMA012-X-05	Umbilical Housing (see <i>Encoder Connector</i>)
6	CMG007	Irrigation Kit
7	PHG014	Probe Holder Spare Parts Kit, 2 Probe
8	MD050-008	SHCS, M4x0.7 x 8 mm, SST
9	BTS042	MICROBE/ROTIX Pivot Tail
10	EA470	3/8 in Wrench

Spare Parts











MICROBE KIT

Encoder Connector Type

JIREH.COM

Connector Type	Company/Instrument	Connector Type	Company/Instrument
B	Olympus - OmniScan MX / Zetec - ZIRCON, TOPAZ	G	Sonotron - Isonic
C	Olympus - Focus LT / Zetec Z-Scan	M	GE - USM Vision
D	Olympus - OmniScan MX2, OmniScan SX	U	Sonatest - VEO, PRISMA
F	TD - Focus Scan, Handy Scan, Pocket Scan	V	Pragma PAUT 16/128, PragmaLite / Pragma UT400

Pivot Button Style

Part #	Length		Part #	Length	
BG0038-05	5 cm (1.97 in)		BG0038-10	10 cm (3.94 in)	
BG0038-15	15 cm (5.91 in)		BG0038-20	20 cm (7.87 in)	
BG0038-25	25 cm (9.84 in)		BG0038-30	30 cm (11.81 in)	
BG0038-35	35 cm (13.78 in)		BG0038-40	40 cm (15.75 in)	
BG0038-45	45 cm (17.72 in)		BG0038-50	50 cm (19.69 in)	
BG0038-55	55 cm (21.65 in)	